

PRODUCT SHEET

Description:

Rail Handle 4507, Aluminum, cc 96mm, 15,5x120mm, Anodized

Item number:

17.02.010-1

Units	Box	Carton	HS Code	Barcode
Pcs.	80	960	7616991099	 5704866457750

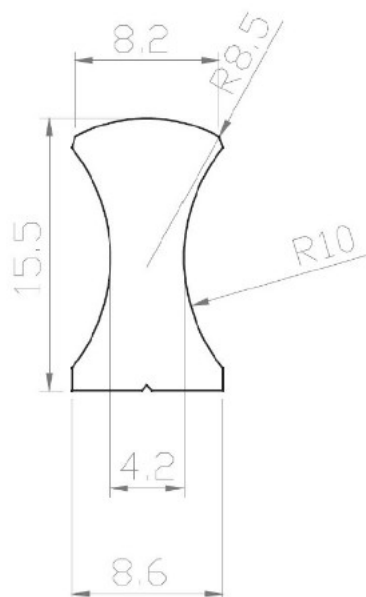

SISO A/S

Mileparken 11
DK-2740 Skovlunde
Denmark
VAT: DK 24786013

Phone +45 45 830 900

www.siso.dk
siso@siso.dk

Danske Bank
Nytorv Branch
Copenhagen
SWIFT: DABADKKK

Account no.
4180 3112 112936
IBAN Account
DK7230003112112936