

PRODUCT SHEET

Description:

Black Anodized Z-Profile, 3200mm, F/"Zapp" Door System

Item number:

28.25.301-3

Units	Box	Carton	HS Code	Barcode
Pcs.	1	10	7604299090	

5704866509671

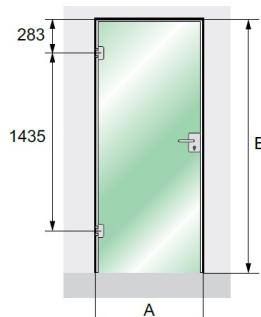
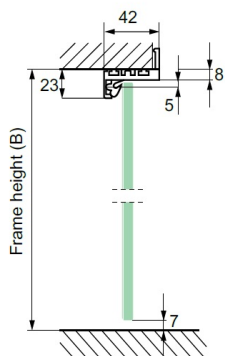
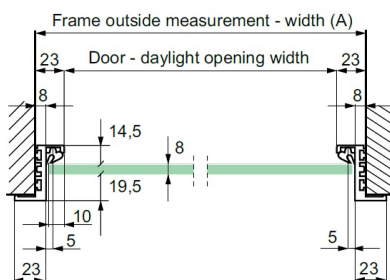
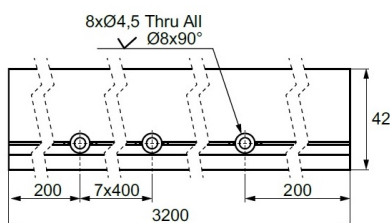
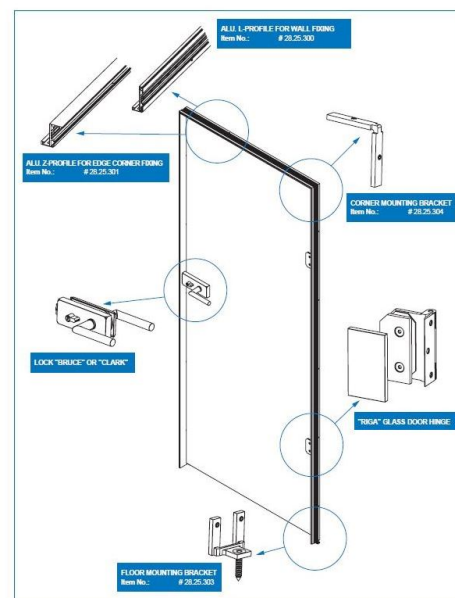
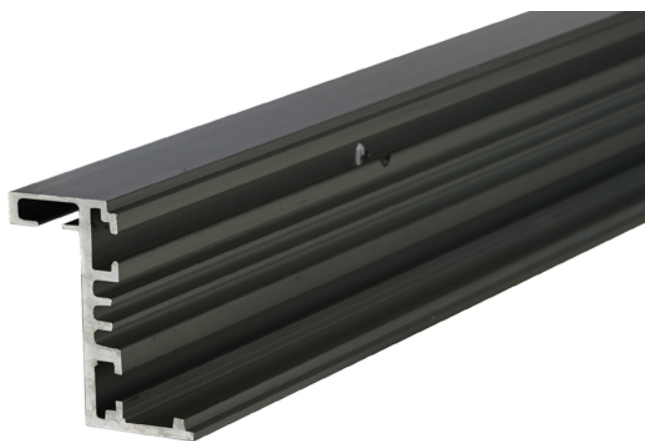

SISO A/S

Mileparken 11
DK-2740 Skovlunde
Denmark
VAT: DK 24786013

Phone +45 45 830 900

www.siso.dk
siso@siso.dk

Danske Bank
Nytorv Branch
Copenhagen
SWIFT: DABADKKK

Account no.
4180 3112 112936
IBAN Account
DK7230003112112936