

PRODUCT SHEET

Description:

Elu-2 Hinge F/20mm Wood, Steel YZP (CR6), SISO DK Logo

Item number:

15.80.130-1

Units	Box	Carton	HS Code	Barcode
Pcs.	1	500	8302100090	
				5704866475624

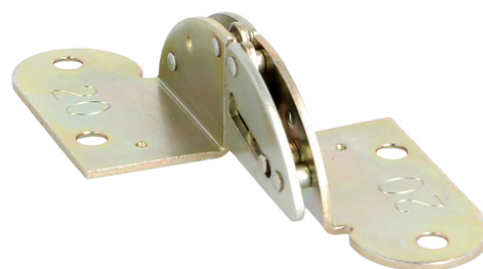

ELU TABLE HINGE 180°

Material: Steel, Yellow Zinc Plated (YZP)
Over all Size: 85 mm x 46 mm

Panel Size X	Item No.	Panel Size X	Item No.
16 mm	# 15.80.110	23 mm	# 15.80.145
18 mm	# 15.80.120	25 mm	# 15.80.155
19 mm	# 15.80.125	30 mm	# 15.80.170
20 mm	# 15.80.130	32 mm	# 15.80.025 (BPL)
22 mm	# 15.80.140		

Spacer For Panel Thickness Reduction = SFPTR*

SFPTR*	Item No.	SFPTR*	Item No.
1 mm	# 15.80.000	2 mm	# 15.80.001

The Spacer gives you the possibility to operate with only one hinge size even though you use different panel thicknesses in your production.

Example: Take a Hinge for 18 mm panel thicknesses and add a 2 mm spacer. Now you can use the hinge for 16 mm panel thickness.

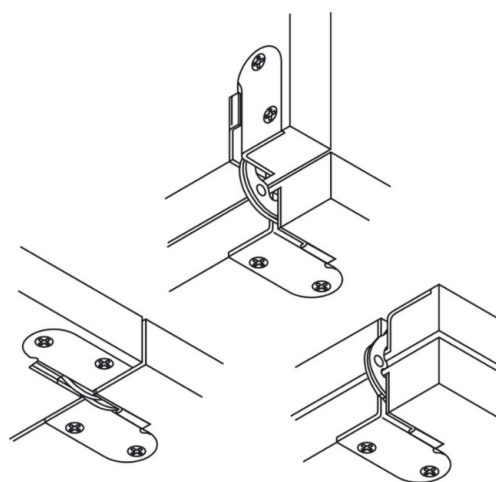
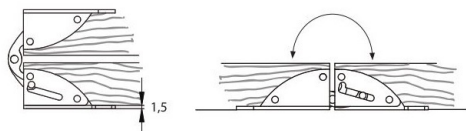
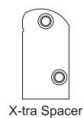
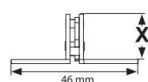
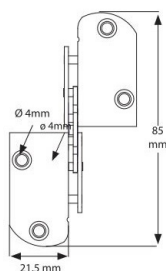

SISO A/S

Mileparken 11
DK-2740 Skovlunde
Denmark
VAT: DK 24786013

Phone +45 45 830 900

www.siso.dk
siso@siso.dk

Danske Bank
Nytorv Branch
Copenhagen
SWIFT: DABADKKK

Account no.
4180 3112 112936
IBAN Account
DK7230003112112936