

PRODUCT SHEET

Description:

Lift Hinge Wall/Glass, CPL Finish, 2,1 Meters, All Accessorie

Item number:

15.23.001-8

Units	Box	Carton	HS Code	Barcode
Set	1	10	8302100090	
				5704866464390

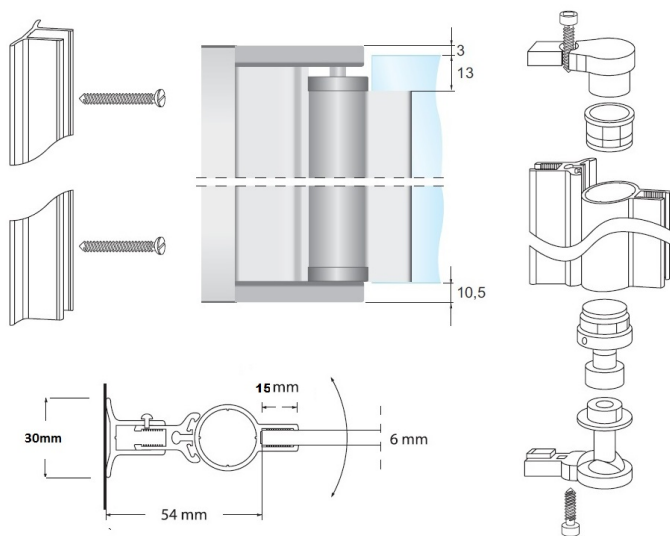

SISO A/S

Mileparken 11
DK-2740 Skovlunde
Denmark
VAT: DK 24786013

Phone +45 45 830 900

www.siso.dk
siso@siso.dk

Danske Bank
Nytorv Branch
Copenhagen
SWIFT: DABADKKK

Account no.
4180 3112 112936
IBAN Account
DK7230003112112936