

PRODUCT SHEET

Description:



Alu Frame Hinge "C", Clip-On, 100DG, NPL, H=0, W/Plate F/ Wood Screws , Inset, W/SISO DK Name Plate, No Screws,, F/19-24mm Alu Frames, cc:28mm On Hinge Head

Item number:

15.03.812-0

Units	Box	Carton	HS Code	Barcode
Pcs.	1	100	8302100090	 5704866103510

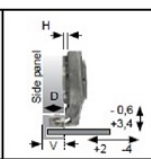
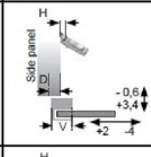
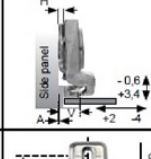
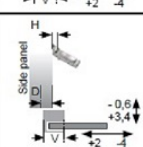
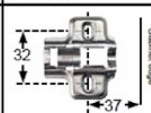
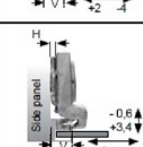

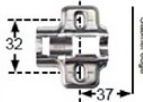
Steel - Nickel Plated		Item No.	D: Overlay calculations	A: Gap calculations																															
Full overlay (A)  	15.03.810 Incl. SISO name plate + mounting plate H = 0	<table border="1"> <tr><th>D</th><th>V</th><th>19</th><th>20</th><th>21</th><th>22</th><th>23</th></tr> <tr><th>H</th><td>0</td><td>17</td><td>18</td><td>19</td><td>20</td><td>21</td></tr> <tr><td>2</td><td>15</td><td>16</td><td>17</td><td>18</td><td>19</td><td></td></tr> <tr><td>4</td><td>13</td><td>14</td><td>15</td><td>16</td><td>17</td><td></td></tr> </table>	D	V	19	20	21	22	23	H	0	17	18	19	20	21	2	15	16	17	18	19		4	13	14	15	16	17						
D	V	19	20	21	22	23																													
H	0	17	18	19	20	21																													
2	15	16	17	18	19																														
4	13	14	15	16	17																														
Half overlay (B)  	15.03.811 Incl. SISO name plate + mounting plate H = 0	<table border="1"> <tr><th>D</th><th>V</th><th>19</th><th>20</th><th>21</th><th>22</th><th>23</th></tr> <tr><th>H</th><td>0</td><td>8</td><td>9</td><td>10</td><td>11</td><td>12</td></tr> <tr><td>2</td><td>6</td><td>7</td><td>8</td><td>9</td><td>10</td><td></td></tr> <tr><td>4</td><td>4</td><td>5</td><td>6</td><td>7</td><td>8</td><td></td></tr> </table>	D	V	19	20	21	22	23	H	0	8	9	10	11	12	2	6	7	8	9	10		4	4	5	6	7	8						
D	V	19	20	21	22	23																													
H	0	8	9	10	11	12																													
2	6	7	8	9	10																														
4	4	5	6	7	8																														
Inset (C)  	15.03.812 Incl. SISO name plate + mounting plate H = 0	<table border="1"> <tr><th>A</th><th>V</th><th>19</th><th>20</th><th>21</th><th>22</th><th>23</th><th>24</th></tr> <tr><th>H</th><td>0</td><td>1,5</td><td>0,5</td><td>-0,5</td><td>-1,5</td><td>-2,5</td><td>-3,5</td></tr> <tr><td>2</td><td>3,5</td><td>2,5</td><td>1,5</td><td>0,5</td><td>-0,5</td><td>-1,5</td><td></td></tr> <tr><td>4</td><td>5,5</td><td>4,5</td><td>3,5</td><td>2,5</td><td>1,5</td><td>0,5</td><td></td></tr> </table>	A	V	19	20	21	22	23	24	H	0	1,5	0,5	-0,5	-1,5	-2,5	-3,5	2	3,5	2,5	1,5	0,5	-0,5	-1,5		4	5,5	4,5	3,5	2,5	1,5	0,5		
A	V	19	20	21	22	23	24																												
H	0	1,5	0,5	-0,5	-1,5	-2,5	-3,5																												
2	3,5	2,5	1,5	0,5	-0,5	-1,5																													
4	5,5	4,5	3,5	2,5	1,5	0,5																													
 	H = 0 f/chipboard screws Clip-on	Delivered as standard mounting plate with all hinges. Chipboard screws to be ordered separately.																																	

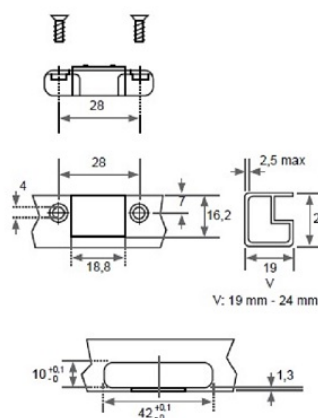

Opening angle:	100°
Mounting of hinge: Screw - on c.c.	28 mm
Width of aluminium frame (V):	19-24 mm

SISO A/S

Mileparken 11
DK-2740 Skovlunde
Denmark
VAT: DK 24786013

Phone +45 45 830 900

www.siso.dk
siso@siso.dk

Danske Bank
Nytorv Branch
Copenhagen
SWIFT: DABADKKK

Account no.
4180 3112 112936
IBAN Account
DK7230003112112936