

PRODUCT SHEET

Description:



Alu Frame Hinge "B", Clip-On, 100DG, NPL, H=0, W/Plate F/ Wood Screws , Half-Overlay, W/SISO DK Name Plate, No Screws,, F/19-24mm Alu Frames, cc:28mm On Hinge Head

Item number:

15.03.811-0

Units	Box	Carton	HS Code	Barcode
Pcs.	1	100	8302100090	 5704866103503

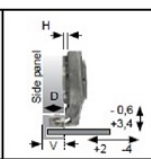
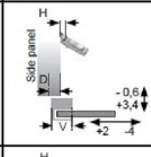
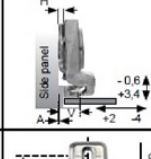
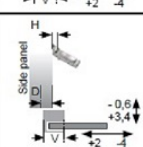
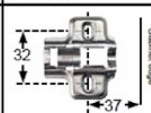
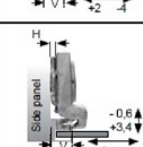

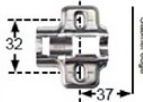
Steel - Nickel Plated		Item No.	D: Overlay calculations	A: Gap calculations																																
Full overlay (A) 		15.03.810 Incl. SISO name plate + mounting plate H = 0	<table border="1"> <tr> <td>D</td> <td>V</td> <td>19</td> <td>20</td> <td>21</td> <td>22</td> <td>23</td> </tr> <tr> <td>0</td> <td>17</td> <td>18</td> <td>19</td> <td>20</td> <td>21</td> <td></td> </tr> <tr> <td>2</td> <td>15</td> <td>16</td> <td>17</td> <td>18</td> <td>19</td> <td></td> </tr> <tr> <td>4</td> <td>13</td> <td>14</td> <td>15</td> <td>16</td> <td>17</td> <td></td> </tr> </table>	D	V	19	20	21	22	23	0	17	18	19	20	21		2	15	16	17	18	19		4	13	14	15	16	17						
D	V	19	20	21	22	23																														
0	17	18	19	20	21																															
2	15	16	17	18	19																															
4	13	14	15	16	17																															
Half overlay (B) 		15.03.811 Incl. SISO name plate + mounting plate H = 0	<table border="1"> <tr> <td>D</td> <td>V</td> <td>19</td> <td>20</td> <td>21</td> <td>22</td> <td>23</td> </tr> <tr> <td>0</td> <td>8</td> <td>9</td> <td>10</td> <td>11</td> <td>12</td> <td></td> </tr> <tr> <td>2</td> <td>6</td> <td>7</td> <td>8</td> <td>9</td> <td>10</td> <td></td> </tr> <tr> <td>4</td> <td>4</td> <td>5</td> <td>6</td> <td>7</td> <td>8</td> <td></td> </tr> </table>	D	V	19	20	21	22	23	0	8	9	10	11	12		2	6	7	8	9	10		4	4	5	6	7	8						
D	V	19	20	21	22	23																														
0	8	9	10	11	12																															
2	6	7	8	9	10																															
4	4	5	6	7	8																															
Inset (C) 		15.03.812 Incl. SISO name plate + mounting plate H = 0	<table border="1"> <tr> <td>A</td> <td>V</td> <td>19</td> <td>20</td> <td>21</td> <td>22</td> <td>23</td> <td>24</td> </tr> <tr> <td>0</td> <td>1,5</td> <td>0,5</td> <td>-0,5</td> <td>-1,5</td> <td>-2,5</td> <td>-3,5</td> <td></td> </tr> <tr> <td>2</td> <td>3,5</td> <td>2,5</td> <td>1,5</td> <td>0,5</td> <td>-0,5</td> <td>-1,5</td> <td></td> </tr> <tr> <td>4</td> <td>5,5</td> <td>4,5</td> <td>3,5</td> <td>2,5</td> <td>1,5</td> <td>0,5</td> <td></td> </tr> </table>	A	V	19	20	21	22	23	24	0	1,5	0,5	-0,5	-1,5	-2,5	-3,5		2	3,5	2,5	1,5	0,5	-0,5	-1,5		4	5,5	4,5	3,5	2,5	1,5	0,5		
A	V	19	20	21	22	23	24																													
0	1,5	0,5	-0,5	-1,5	-2,5	-3,5																														
2	3,5	2,5	1,5	0,5	-0,5	-1,5																														
4	5,5	4,5	3,5	2,5	1,5	0,5																														
		H = 0 f/chipboard screws Clip-on	Delivered as standard mounting plate with all hinges. Chipboard screws to be ordered separately.																																	

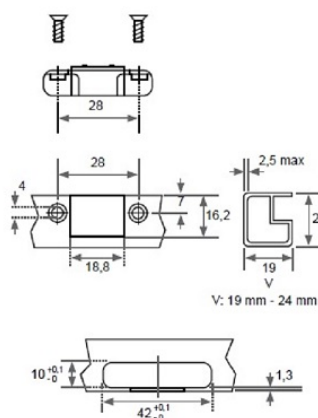

Opening angle:	100°
Mounting of hinge: Screw - on c.c.	28 mm
Width of aluminium frame (V):	19-24 mm

SISO A/S

Mileparken 11
DK-2740 Skovlunde
Denmark
VAT: DK 24786013

Phone +45 45 830 900

www.siso.dk
siso@siso.dk

Danske Bank
Nytrov Branch
Copenhagen
SWIFT: DABADKKK

Account no.
4180 3112 112936
IBAN Account
DK7230003112112936