

# PRODUCT SHEET

## Description:

Elec. Combi. Cam Lock, "VIC",  $\varnothing 19 \times 30 \text{mm}$ , Vertical, Uni, Black All Zamak, Public/Private, W/Master Key System #07, 3 Level, Management, W/Auto-timer Function, IP65 Rating, Powered by, CR2450 Button Battery, 30.000 Cycles, CE, REACH and Rohs, Certified, Universal - No right hand or left hand

## Item number:

14.60.415-0

Units	Box	Carton	HS Code	Barcode
Pcs.	1	50	8301300000	 5704866509213

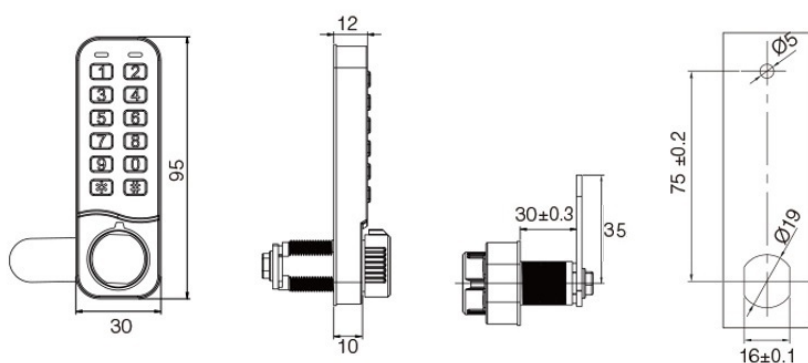

Vertical

## SISO A/S

Mileparken 11  
DK-2740 Skovlunde  
Denmark  
VAT: DK 24786013

Phone +45 45 830 900

[www.siso.dk](http://www.siso.dk)  
[siso@siso.dk](mailto:siso@siso.dk)

Danske Bank  
Nytorv Branch  
Copenhagen  
SWIFT: DABADKKK

Account no.  
4180 3112 112936  
IBAN Account  
DK7230003112112936