

# PRODUCT SHEET

## Description:

Central Lock 851N/600mm,  $\varnothing 19 \times 22$ mm, NPL, CK SISO, 13mm Pegs W/Screws

## Item number:

14.01.328-0

Units	Box	Carton	HS Code	Barcode
Pcs.	24	120	8301300000	
				5704866033343

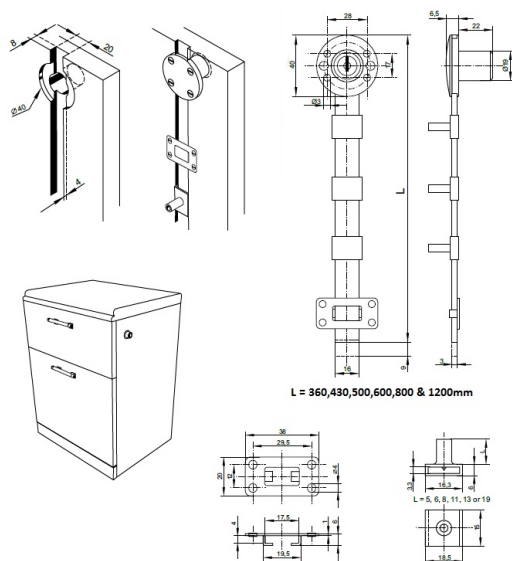

## SISO A/S

Mileparken 11  
DK-2740 Skovlunde  
Denmark  
VAT: DK 24786013

Phone +45 45 830 900

[www.siso.dk](http://www.siso.dk)  
[siso@siso.dk](mailto:siso@siso.dk)

Danske Bank  
Nytorv Branch  
Copenhagen  
SWIFT: DABADKKK

Account no.  
4180 3112 112936  
IBAN Account  
DK7230003112112936