

## PRODUCT SHEET

### Description:

Alu Leg Niko 60x60mm, H 150mm PL 42x42x2mm, cc 32x32mm Stem: M10X27mm ,Silver Sprayed Finish

### Item number:

06.09.473-0

Units	Box	Carton	HS Code	Barcode
Pcs.	1	100	7616991099	
				5704866004091

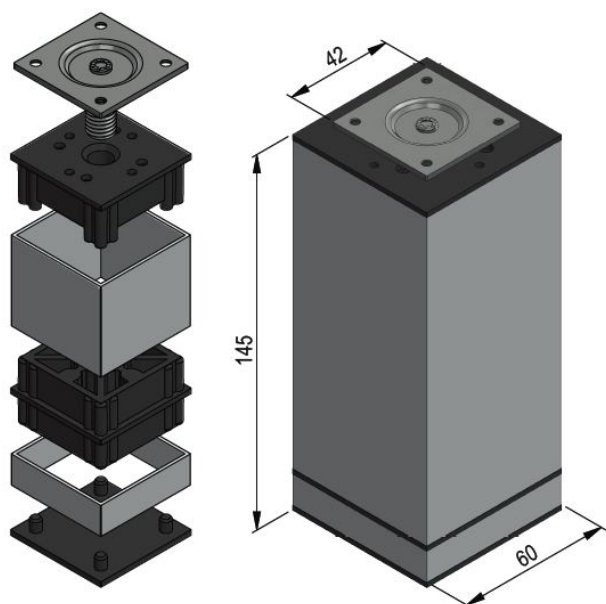

### SISO A/S

Mileparken 11  
DK-2740 Skovlunde  
Denmark  
VAT: DK 24786013

Phone +45 45 830 900

[www.siso.dk](http://www.siso.dk)  
[siso@siso.dk](mailto:siso@siso.dk)

Danske Bank  
Nytorv Branch  
Copenhagen  
SWIFT: DABADKKK

Account no.  
4180 3112 112936  
IBAN Account  
DK7230003112112936