

PRODUCT SHEET

Description:

Shower Hinge "Tex III", 180DG, CPL, Glass/Glass, 6-10mm. Glass Thickness, W/15 DG Angle Adjustment Function, & 25DG Return Function, Brass Material, Straight Edges., Incl. 4 x Transp. 1mm & 4 x Transp. Cushions 2mm Thickness

Item number:

15.24.052-0

Units	Box	Carton	HS Code	Barcode
Pcs.	1	20	8302100090	 5704866501668

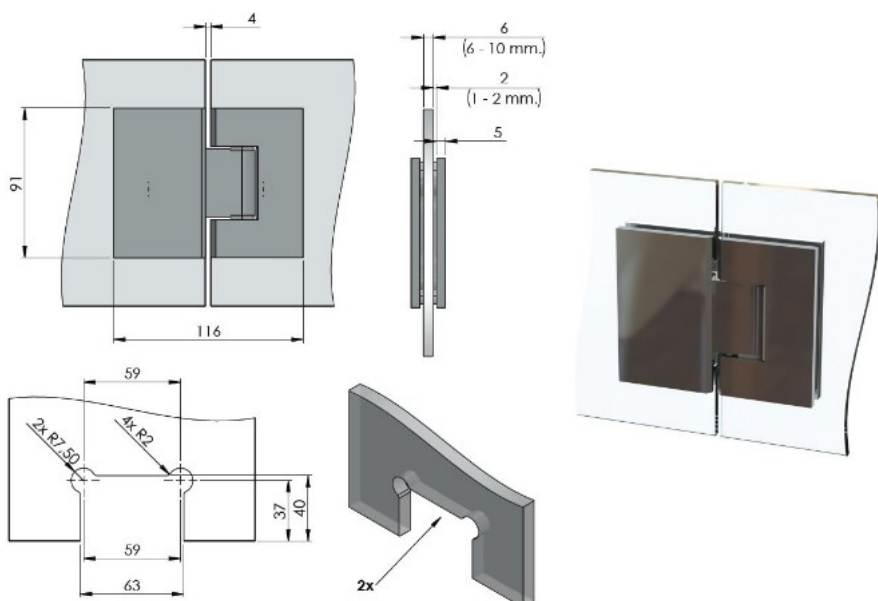

SISO A/S

Mileparken 11
DK-2740 Skovlunde
Denmark
VAT: DK 24786013

Phone +45 45 830 900

www.siso.dk
siso@siso.dk

Danske Bank
Nytorv Branch
Copenhagen
SWIFT: DABADKKK

Account no.
4180 3112 112936
IBAN Account
DK7230003112112936